

SIMCO (Nederland) B.V.  
Postbus 71  
7240 AB Lochem, The Netherlands  
Telephone +31-(0)573-288333  
Fax +31-(0)573-257319  
E-mail [general@simco-ion.nl](mailto:general@simco-ion.nl)  
Internet <http://www.simco-ion.nl>  
Traderegister Apeldoorn No. 08046136

## Manager IQ Easy



**Control unit**



The Dutch manual is the original manual and is translated to German and English.

## CONTENTS

<b><u>Preface</u></b> .....	<b>3</b>
<b><u>Explanation of symbols</u></b> .....	<b>3</b>
<b>1 Introduction</b> .....	<b>5</b>
<b>2 Description and operation</b> .....	<b>6</b>
<b>3 Safety</b> .....	<b>7</b>
<b>4 Technical specifications</b> .....	<b>8</b>
<b>5 Installation</b> .....	<b>9</b>
<b>5.1 Checks</b> .....	<b>9</b>
<b>5.2 General</b> .....	<b>9</b>
<b>5.3 Fitting the Manager IQ Easy</b> .....	<b>10</b>
<b>5.4 Electrical installation</b> .....	<b>10</b>
5.4.1 AC version .....	11
5.4.2 24 V DC version .....	11
5.4.3 Devices .....	11
5.4.4 Machine I/O Input and output connections .....	12
5.4.5 Fieldbus connection .....	13
5.4.6 Ethernet connection .....	13
5.4.7 Serial communication COM ports .....	13
5.4.8 Installation of the protection cover .....	14
<b>5.5 Mounting the manager in a machine panel</b> .....	<b>14</b>
<b>6 Commissioning and operation</b> .....	<b>19</b>
<b>6.1 Main screen</b> .....	<b>20</b>
<b>6.2 Device Standby &amp; Active</b> .....	<b>20</b>
6.2.1 Global Device Standby & Active.....	21
<b>6.3 Device screen tabs</b> .....	<b>21</b>
6.3.1 Device <i>Information</i> tab .....	21
6.3.2 Device <i>Graphics</i> tab .....	21
6.3.3 Device <i>Action log</i> tab .....	22
6.3.4 Device <i>Data log</i> tab.....	22
6.3.5 Device <i>Maintenance</i> Tab .....	22
<b>6.4 Selecting user levels (access protection)</b> .....	<b>22</b>
6.4.1 Setting the Password for advanced mode and expert mode .....	23
6.4.2 Reset Password .....	23
<b>6.5 Setting device parameters on the Information screen</b> .....	<b>23</b>
6.5.1 Setting the Device name, Device Machine position .....	23
6.5.2 Setting the Device Graphic refresh time (expert mode).....	24
6.5.3 Switching Device Remote on/off through the remote on/off input on the Machine I/O connector or via fieldbus (expert mode) .....	24
6.5.4 (De)activating Device Data logging (expert mode) .....	24
6.5.5 Adjusting the Device Autorun parameter (expert mode) .....	24
6.5.6 Setting the Device pictogram Favorites screen position (expert mode) .....	25
<b>6.6 Setting Manager parameters in Global Settings screen (expert mode)</b> .....	<b>25</b>
6.6.1 Setting Manager name, Manager Machine position .....	25
6.6.2 (De)activating Manager Data logging (expert mode) .....	25

6.6.3 Setting the Datalog refresh time (expert mode).....	25
6.6.4 Changing date and time format (expert mode).....	25
6.6.5 Switching buzzer on/off or adjusting it (expert mode).....	26
6.6.6 Retrieving Ethernet IP address (expert mode) .....	26
<b>6.7 Setting Manager Backplane parameters in Global <i>Settings</i> screen (expert mode) .....</b>	<b>26</b>
6.7.1 Manager Backplane Device time-out (expert mode).....	26
6.7.2 Manager Backplane RS485 A & B line switch (expert mode) .....	27
6.7.3 Manager Backplane Autorun parameter .....	27
6.7.4 Making Device Port 5 & 6 suitable for non IQ Devices or IQ devices (expert mode) .....	27
6.7.5 Switching Machine I/O digital output between Open Emitter and Open Collector (expert mode) .....	27
<b>7 Functional check .....</b>	<b>27</b>
7.1 Warnings.....	27
7.2 Alarms .....	27
7.3 Data logging (as of <i>Software version V1.1.0</i> of the manager) .....	28
7.3.1 Copy data from intern memory to PC.....	28
7.3.2 Data logging to USB .....	29
<b>8 Maintenance.....</b>	<b>29</b>
<b>9 Faults.....</b>	<b>30</b>
<b>10 Repairs.....</b>	<b>31</b>
<b>11 Disposal .....</b>	<b>31</b>
<b><u>Spare parts</u> .....</b>	<b>32</b>

## Preface

This manual is intended for the installation and use of the MANAGER IQ EASY.  
This manual describes the installation and basic menus of the manager itself. The different possibilities of the connected equipment using the manager is described in detail in the manual of the relevant device.  
The term *devices* in this manual refers to Simco-Ion 24V DC equipment suitable for connecting to the Manager IQ Easy.

This manual must be available at all times to staff operating the equipment.  
Read through the entire manual before installing and commissioning the product.  
Follow the instructions set out in this manual to ensure proper operation of the product and to retain your entitlement under the guarantee.  
The guarantee terms are set out in the General Terms and Conditions of Sale of SIMCO (Nederland) B.V.

## Explanation of symbols

The following symbols may appear in this manual or on the product.



**Warning:**  
Indicates special information to prevent injury or significant damage to the product or the environment.



**Danger:**  
Indicates information for preventing electric shocks.



**Attention**  
Important information for making the most efficient use of the product and/or for preventing damage to the product or the environment.



Nothing connected



Neutralizing equipment, e.g. Performax IQ Easy



Charging equipment, e.g. ChargeMasterMicro IQ Easy



Sensor (measuring equipment) e.g. Sensor IQ Easy bar

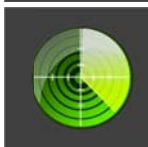

Detection equipment (perforation detector), e.g. Perfomaster

The background colors indicate the status of connected devices:



Inactive or no communication



Active and operating OK, without warnings or alarms



Standby, waiting for start command



Active, but with a warning



Active, but with an alarm

The following symbols are also used:



Settings



Information

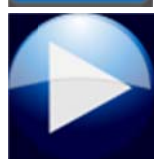

Active



Standby



Inactive or incorrect entry

# 1 Introduction

The Manager IQ Easy is equipped with an on/off switch, 6 connectors for connecting Simco-Ion equipment (devices), various I/O connectors and a 7" touch screen as a user interface. The user interface is in colour and can be easily operated using a finger or stylus.

Using the manager, Simco-Ion equipment can be configured, read out, monitored and controlled. Also, you can easily control the quality, using the data and action logging feature on the manager. You can read out this data with an FTP connection through the Ethernet connection or save it on an external USB drive.

Remote control is possible using an optional fieldbus and through the machine I/O connector with which different digital and analog in- and outputs can be configured.

To further expand the system to up to 30 devices, the system has 2 serial COM connectors for connecting Extension IQ Easy control units.

The Manager IQ Easy is available with 24 V DC input and as an universal 100-240 V AC 50-60 Hz version.

Each Device port provides the 24V DC supply voltage and the communication with the device. All device ports and other I/O ports are controlled through the internal IQ Easy Backplane interface.

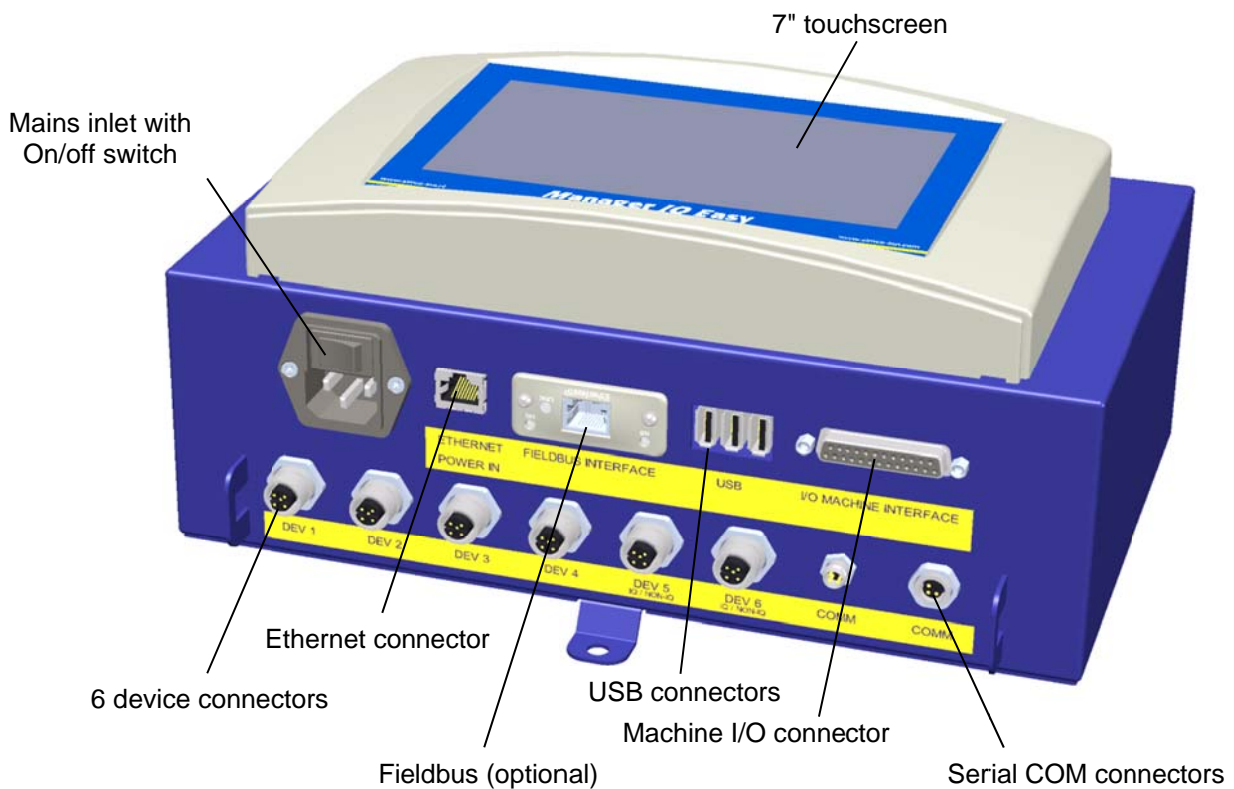

Figure 1, Manager IQ Easy



## 2 Description and operation

After starting the manager, it will display the status of the connected equipment on the main screen.

6 possible devices are displayed on the main screen. The operating status of each device can be read directly through the colours and icons used.

If you require more information regarding a specific device, you can retrieve this information by pressing the appropriate icon.



4 tabs will then be displayed. If a tab has several pages, you can scroll through them, using the   buttons. Each tab contains specific information about the connected device, which will vary for each type of device. More or less info is displayed depending on the log-on level for the user level.





**Information:** various parameters, settings, limit values, operation modes and current readings are displayed in a list.

**Graphics:** graphical representations of actual measurement values of the device

**Action Log:** list of status changes of the device with date and time stamp

**Data Log:** list of readings with date and time stamp.

**Maintenance:** possible maintenance instructions.

On each tab, you can set the device to standby  or active  mode.

This specific information of each tab is described in the manual of the corresponding device.

### 3 Safety

The following safety guidelines must be observed in order to prevent physical injury and damage to objects or the Manager IQ Easy itself.



#### **Warning:**

- Electrical installation must be carried out by an electrical engineer with relevant training and qualifications and in accordance with the applicable national and local regulations.
- The Manager IQ Easy must not be used in any environment where there are fire or explosion hazards.
- The Manager IQ Easy must not be exposed to vibrations or shocks.
- Use the Manager only in combination with matching Simco-Ion equipment.
- Also read the manual of the equipment to be connected before commissioning.
- The Manager IQ Easy is not intended as a safety component in machines.
- Do not install the manager in dirty, damp or any other areas in which chemicals or other corrosive materials are used.



#### **Danger:**

- Make sure that the equipment is properly earthed. Earthing is necessary to ensure proper and safe operation and to prevent electric shocks upon contact.  
The AC version is earthed through the power cable. Plug this into an earthed outlet.  
With the 24 V DC version, the earthing connector of the 24 V power connector has to be connected to the machine earthing or an earthed machine part.
- To guarantee safe operation, keep the Manager IQ Easy free of dirt, dust and moisture.
- The device may only be serviced by qualified Simco-Ion staff.



#### **Note:**

- Making changes, adjustments etc. without prior written consent or carrying out repairs using non-original parts will invalidate the device's guarantee.

Except for the 230 AC input connector, all connectors for the devices and various I/O have signals that are working on a safe 24 V DC.

That is why all these inputs and outputs can be connected and disconnected safely while the Manager IQ Easy is operating.



## 4 Technical specifications

Supply voltage	100 – 240 V AC nom. (90 – 305 V AC) 24 V DC -3/+10%
Frequency	50 – 60 Hz nom. (47 – 63 Hz)
Max power consumption	300 W (100 – 240 V AC version) 360 W (@15 A) (24 V DC version)
Purpose	Industrial, indoor use
Protection class	IP52
Operating temperature	0 – 55 °C
Installation	Free of dust and vibration
Device output 100-240 V AC version	24 V DC 3 A max. per port, total max. 9 A
Device output 24 V DC version	24 V DC 3 A max. per port, total max. 13 A
Machine I/O	
Digital inputs	10-30 V 25 mA max.
Analog input	0-10 V 0,6 mA / 0- 20 mA / 4- 20 mA
Digital outputs	OE/OC 24 V DC nom. Max. 30V 25 mA
USB	3x USB 2.0
Ethernet	1x RJ45 8-pin connector
Fieldbus (optional)	1x Anybus interface
Weight	5,5 kg (100 – 240 V AC version) 3,9 kg (24 V DC version)

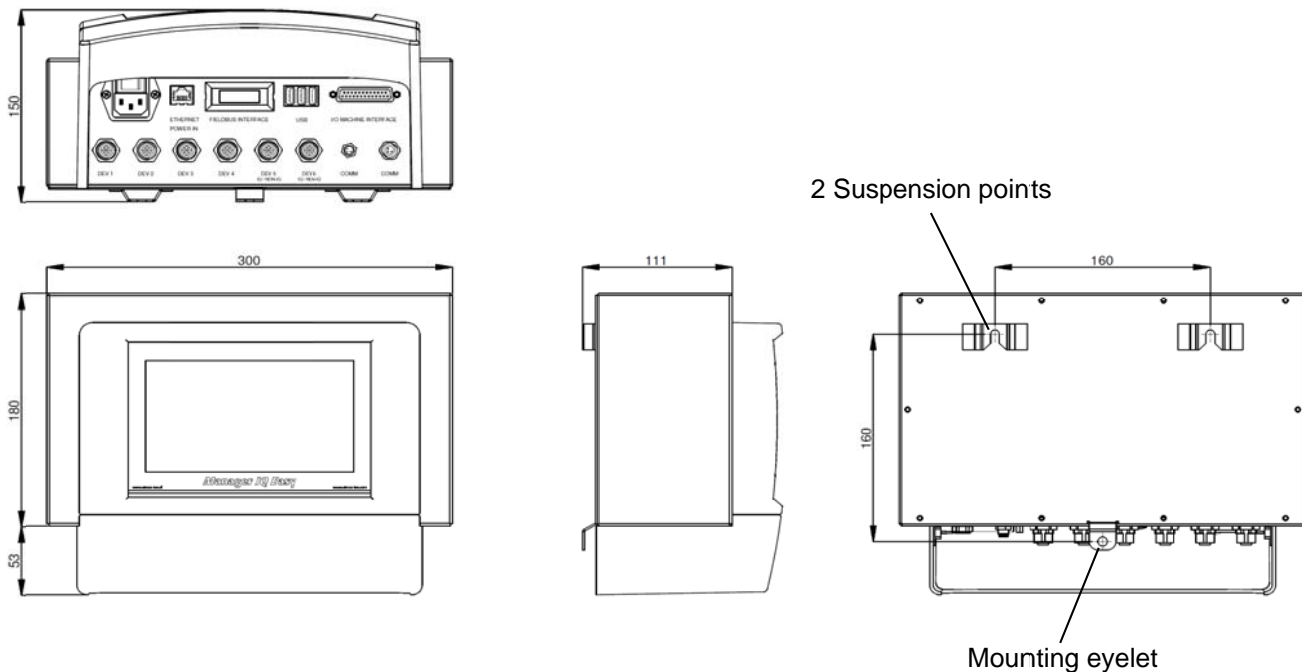

Figure 2, Dimensions Manager IQ Easy and Extension IQ Easy

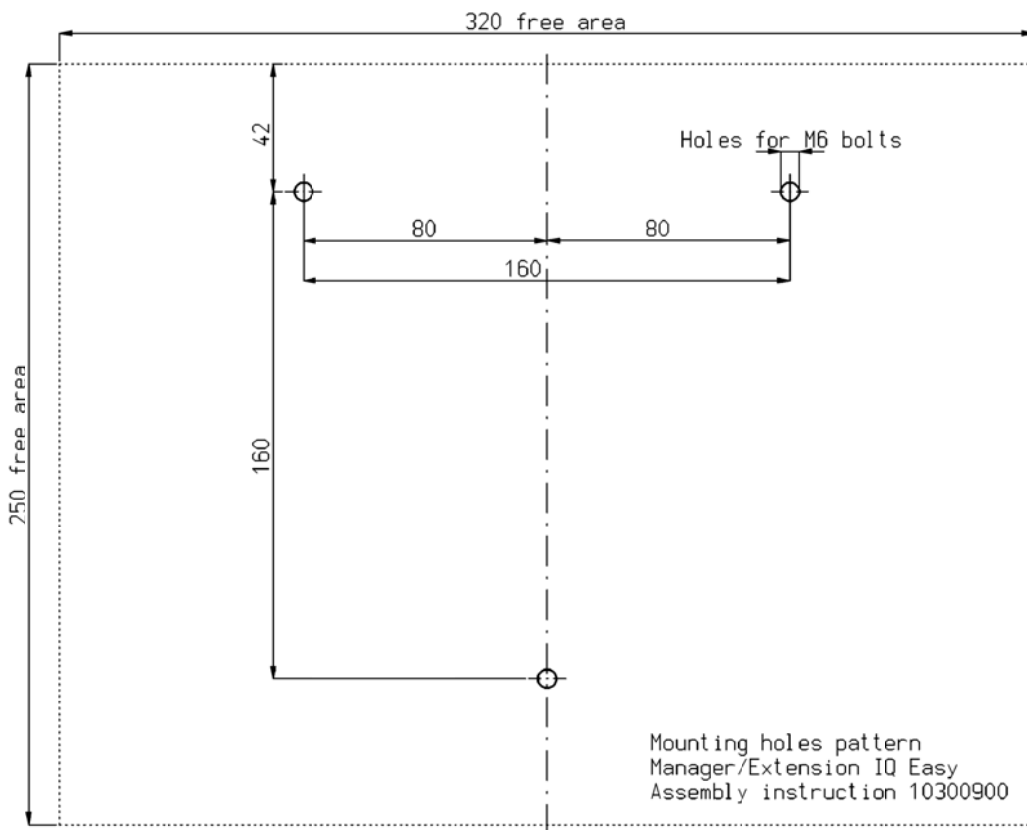

Figure 3, Drilling template Manager IQ Easy and Extension IQ Easy

## 5 Installation



### Warning:

- The electrical installation must be carried out by an electrical engineer with the relevant training and qualifications.
- Disconnect the power supply before carrying out any work on the unit.
- Consult the manuals of the device to be connected for proper and safe connecting and use of the device.

### 5.1 Checks

- Check that the equipment is undamaged and that you have received the correct version.
- Check whether the data on the packing slip corresponds to the data shown on the product received.
- Check whether the voltage shown on the rating plate corresponds to the mains voltage you intend to use.

*If you have any problems or are unsure, please contact Simco-Ion or your regional agent.*

### 5.2 General

Place the manager on a well visible and easily accessible place on or nearby the machine.

### 5.3 Fitting the Manager IQ Easy

The Manager IQ Easy can be placed on a flat surface or mounted in a machine panel.

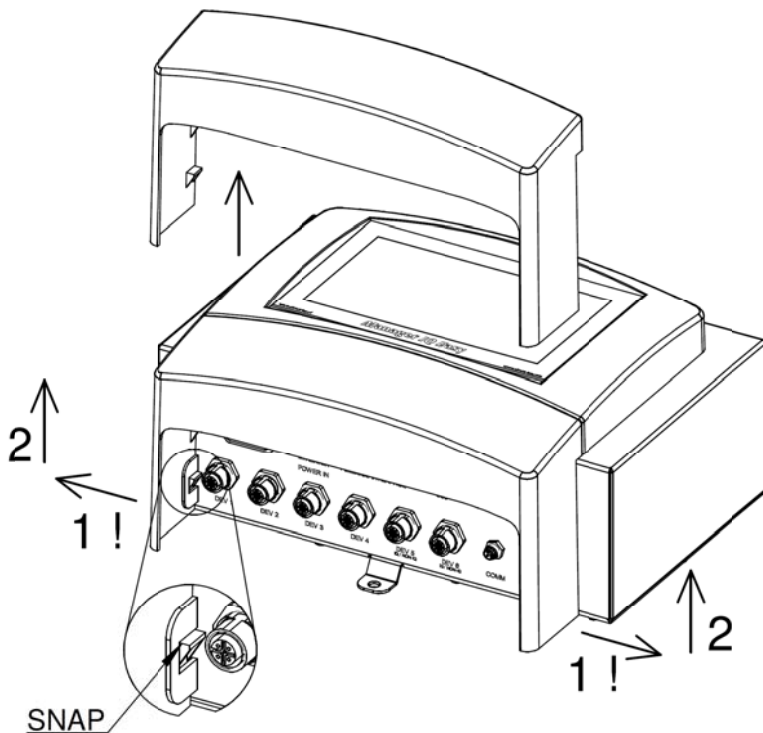

Figure 4, Removal of the plastic bottom cover Manager IQ Easy and Extension IQ Easy.

Mounting on a flat surface:

- Remove the plastic bottom cover of the manager by bending the side flaps slightly outward and sliding the cover up.
- Use the supplied drilling templates to mark the mounting holes. Make sure that there is sufficient space at the bottom for installing the cables.
- Drill the mounting holes into the mounting surface, mount suitable bolts into the two top holes and allow the bolts to stick out 2,5 mm.
- Hang up the manager with suspension points behind the bolt heads.
- Secure the lower mounting eye of the manager with a suitable bolt.

### 5.4 Electrical installation



**Warning:**

- **Disconnect the power supply before carrying out any work on the unit.**
- **The electrical installation must be carried out by an electrical engineer with the relevant training and qualifications.**
- **Make sure that the equipment is properly earthed. Earthing is necessary to ensure proper and safe operation and to prevent electric shocks upon contact.**  
**With the AC version, plug the power cable into an earthed outlet.**  
**With the 24 V DC version, the earthing connector of the 24 V power connector has to be connected to the machine earthing or an earthed machine part.**
- **Connect the manager in accordance with local regulations.**

### 5.4.1 AC version

- Plug the power cable into the IEC connector and plug the outlet plug into an earthed wall outlet.

### 5.4.2 24 V DC version

- Connect the 24 V DC power connector as shown in figure 5.
- Connect the earthing (ground) point with an earthed machine part or a shared earthing point.

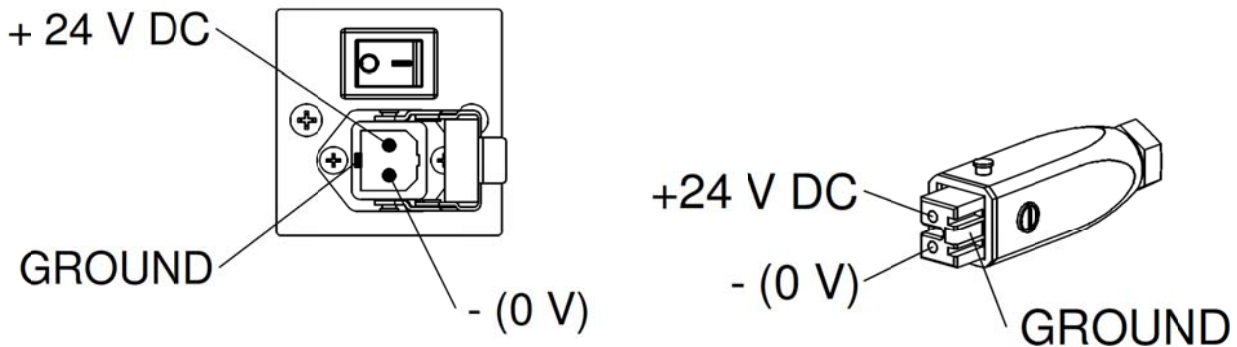

Figure 5, 24 V Input Manager IQ Easy

### 5.4.3 Devices

6 M12 device ports are available for connecting various Simco-Ion devices. Connect the devices with the appropriate M12 device ports 1 to 6.

Connecting is possible using standard cables with M12 5 pin male-female connectors.

The length of the cables is limited since the supply voltage of the devices is also routed through this cable. If the desired length exceeds the maximum specified length, a cable with a larger diameter for the used wires may be selected, so that the required supply voltage is still available during operation.

For this, Simco-Ion provides separate M12 5 pin connectors for connecting these cables (the connection between the manager and the device is 1: 1) see also figure 6.

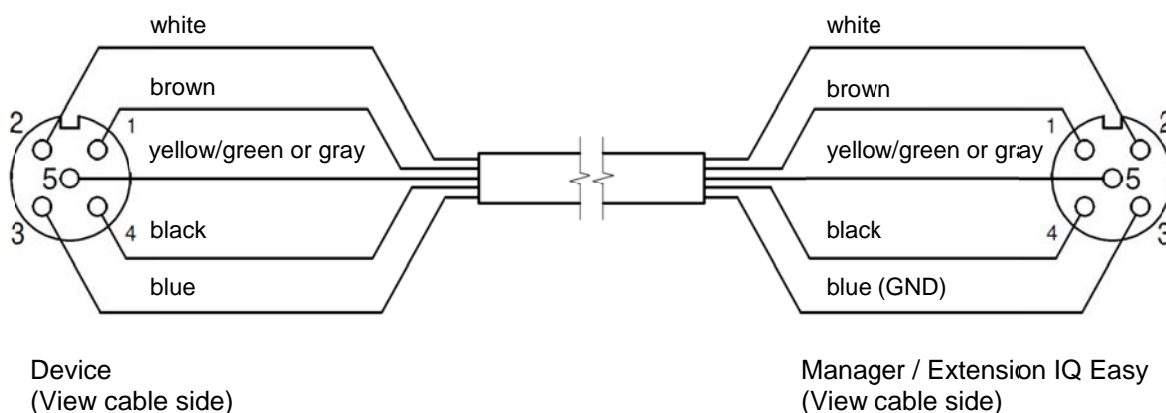

Figure 6, Wiring device to Manager IQ Easy and Extension IQ Easy

If an old generation (non IQ) device is used, preferably connect this with ports 5 or 6 IQ/Non-IQ. These ports can be configured so that *remote on/off* and operation OK feedback can be

processed by the Manager IQ.

For this, use regular 1:1 male-female cables with M12 5 pin connectors as well.

#### 5.4.4 Machine I/O Input and output connections

The manager has a 25-pin Sub D connector for which various in- and output signals are available. These can easily be connected to a machine controller or PLC, making it possible to transmit warnings and alarms to the machine.

##### 5.4.4.1 Digital outputs

The digital output signals indicate the status of the devices connected to the manager and are available for connection to a machine controller (PLC).

The digital outputs can be configured in the manager both as Open Collector (OC) and Open Emitter (OE). For this, see section 6.7.5. By default, these are configured as Open Emitter. The output is then switched from the 24 V DC.

The PLC input can then be connected to the external GND.

For connecting these, see figure 7.

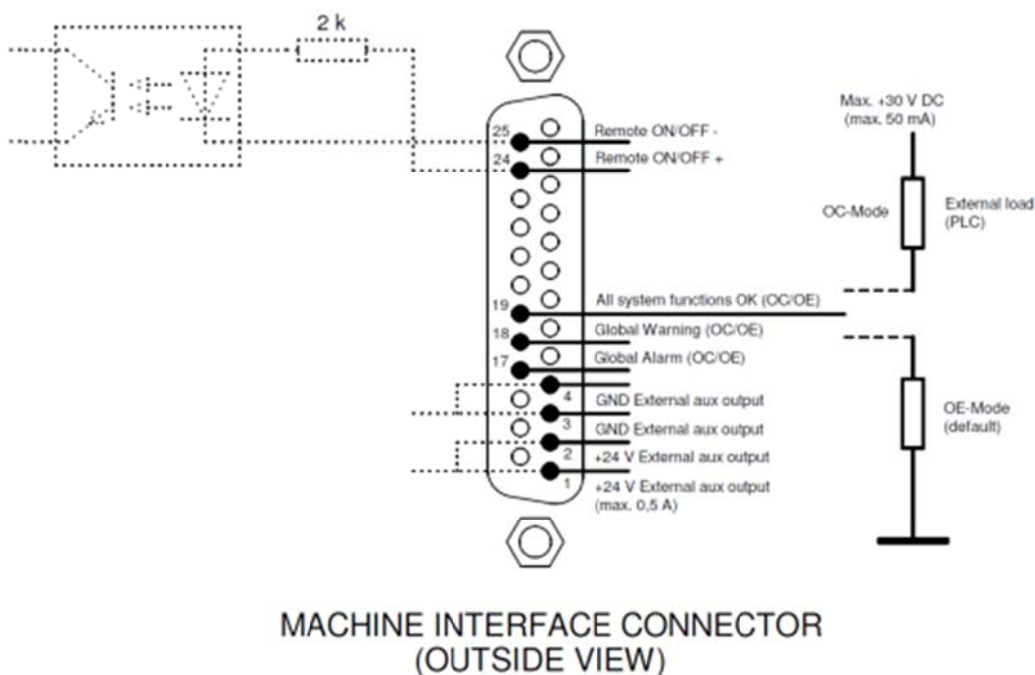

Figure 7, Wiring digital outputs on the machine interface connector

Available signals:

- 19: All systems OK – indicates that the manager and all connected devices are operating properly.
- 18: Global warning – indicates that the manager or a connected device is generating a warning.
- 17: Global Alarm – indicates that the manager or a connected device is generating an alarm.

### 5.4.4.2 Remote on/off input

Each connected device can be switched via the remote on/off input. How to connect the device with this input is explained in the manual of the corresponding device (remote on/off source parameter).

- Connect an external 24 V switching signal between pins 24 and 25 (24 V = remote on, 0 V = remote off).
- Or: Use the 24 V DC output and connect a potential-free switching contact between pins 1 and 24 and create a connection between pin 3 and 25.

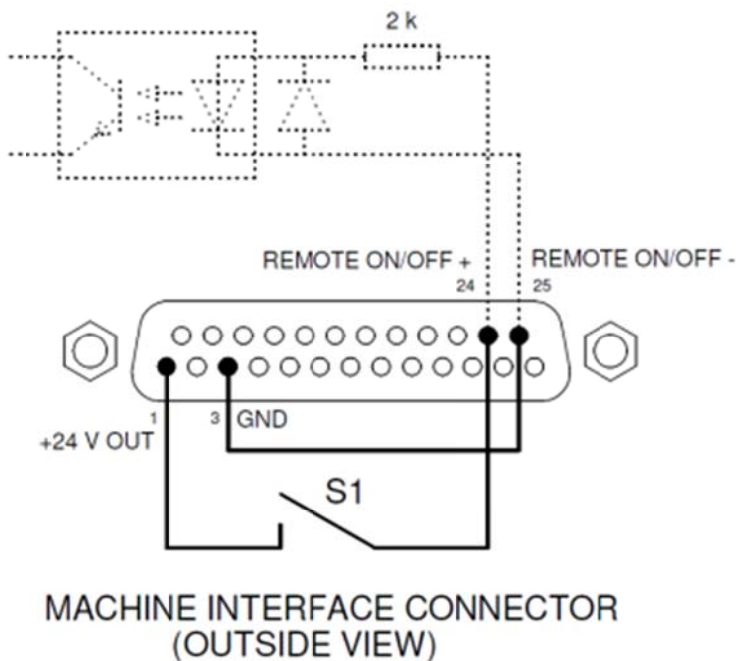

Figure 8, Wiring Remote on/off input on the machine interface connector

### 5.4.5 Fieldbus connection

With an optional fieldbus connection (Profibus, CAN Open, Ethernet IP, etc.), controls such as remote on/off, warnings and alarms can be connected to a machine control.

For this, a Fieldbus interface module is mounted into the Anybus slot at the factory.

For connecting these fieldbuses, follow the general instructions applicable to these fieldbuses.

### 5.4.6 Ethernet connection

For transmitting datalog data from the Manager IQ Easy to a PC, the manager can be connected to a network. For wiring, a standard UTP cable with an 8-pole RJ45 connector can be used.

An Ethernet IP address has to be assigned by the network (DHCP).

For retrieving the assigned IP address, see section 6.6.6

### 5.4.7 Serial communication COM ports

For expanding the system with more than 60 devices, two COM ports are available to which extension IQs can be connected. Standard cables with M8-3 pin male-female connectors can be used for this. These are available from Simco-Ion.

#### 5.4.8 Installation of the protection cover

- When all cables are connected, the cable protection cover can be mounted.

#### 5.5 Mounting the manager in a machine panel

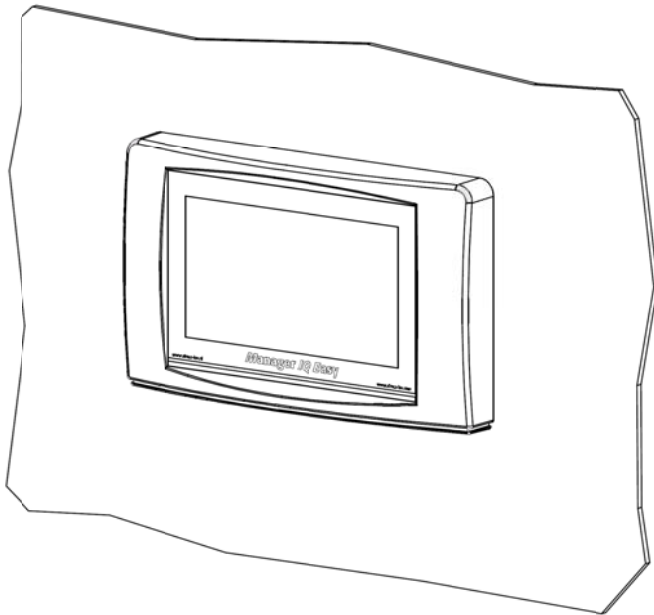
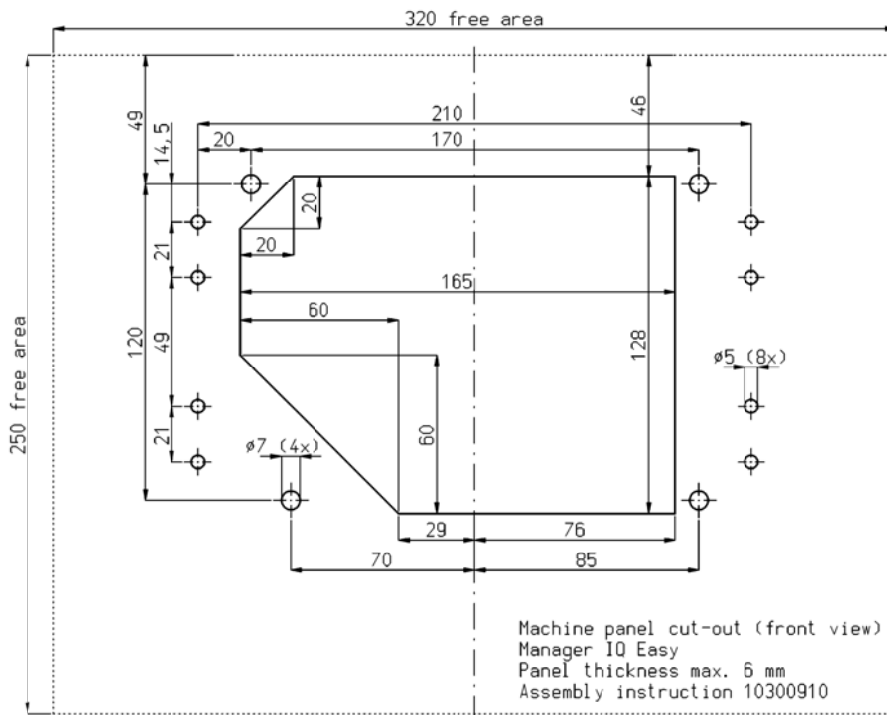

Figure 9, Manager IQ Easy mounted in a machine panel

The Manager IQ Easy can be mounted into a machine panel so that only the plastic part of the Manager is visible. The wiring will then be hidden behind the machine panel. The maximum thickness of the machine panel is 6 mm.

Follow the steps below to mount the Manager IQ Easy.

- Drill and saw the necessary recesses and holds into the machine panel. Use the supplied drilling template for this. Make sure you leave the required free space around the holes.



- The plastic front of the Manager IQ Easy is attached to the housing by means of 4 snap connectors. Carefully pull away the plastic front from the housing. The plastic part can be loosened using a flat screwdriver. There are two recesses below the plastic part for this. Note: Do not pull on the wiring between the front and the housing.

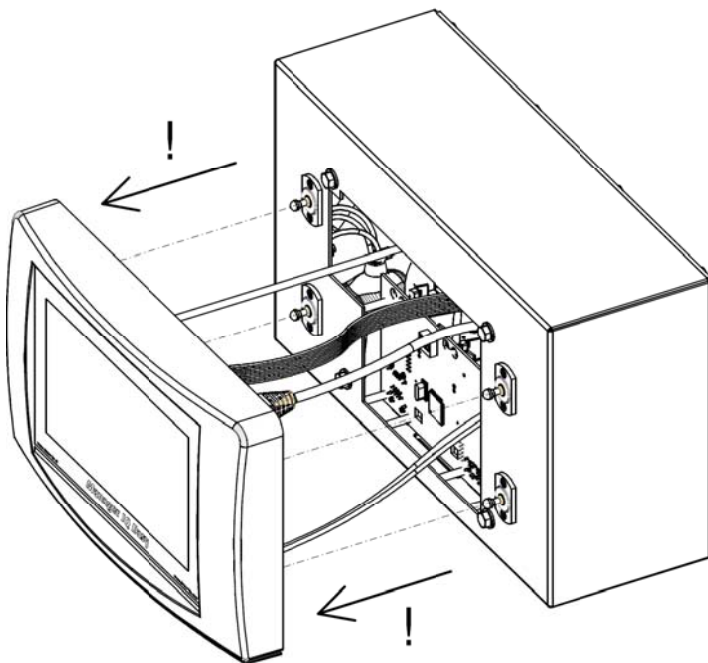

- Remove all connectors from the front.
- Remove the M5 tap bolts and washers (1) and the 4 snap connectors (2 and 3) from the housing.



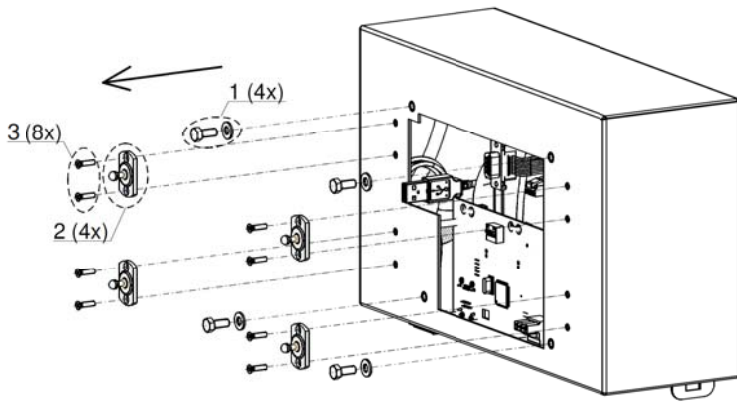

- Place the housing behind the machine panel and secure it with the 4 tap bolts and washers (1). Make sure that the wires are not squeezed between the housing and the machine panel.

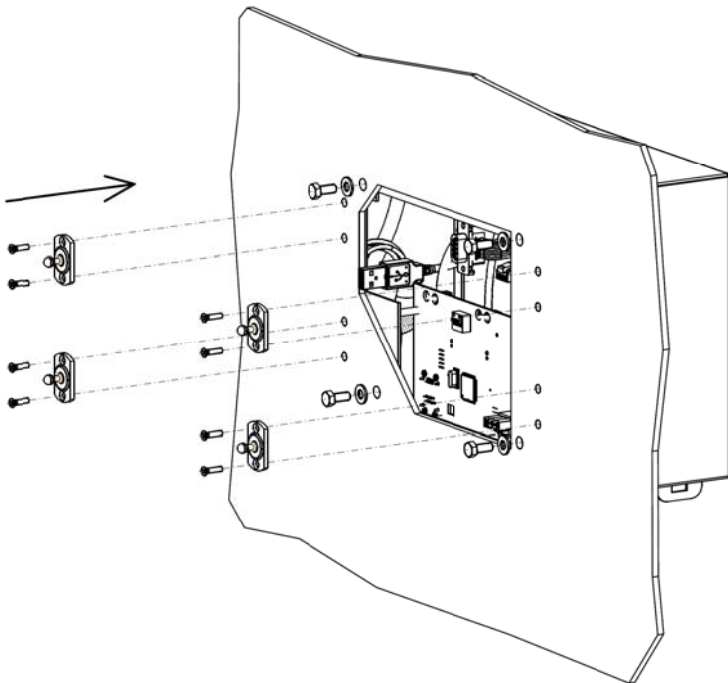

- Screw the four snap connectors into the housing through the machine panel.

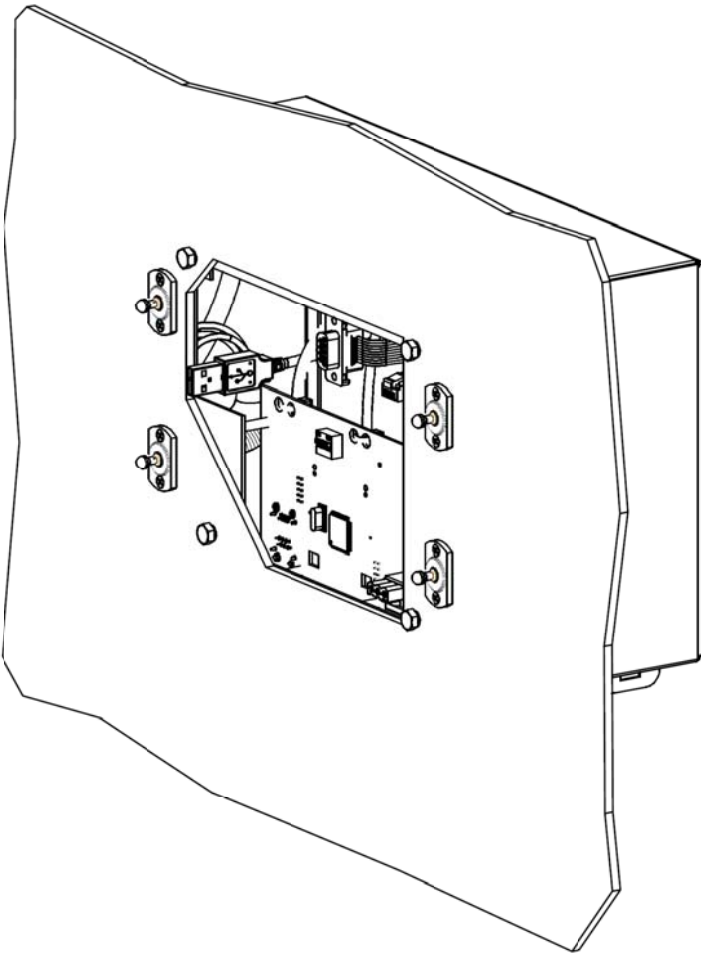

- Mount the wiring connectors from the housing back onto the front.

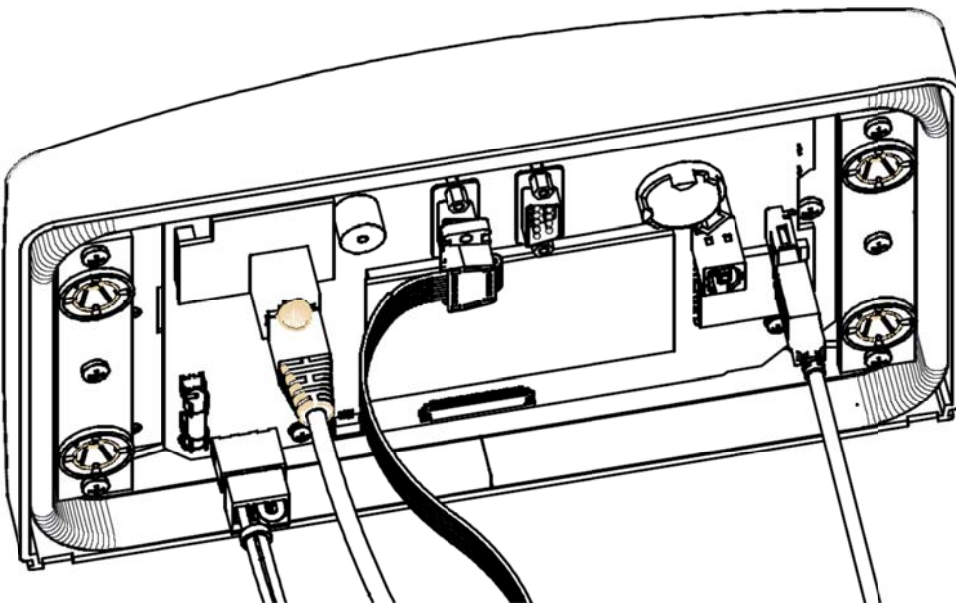

- Click the front onto the four snap connectors on the machine panel.

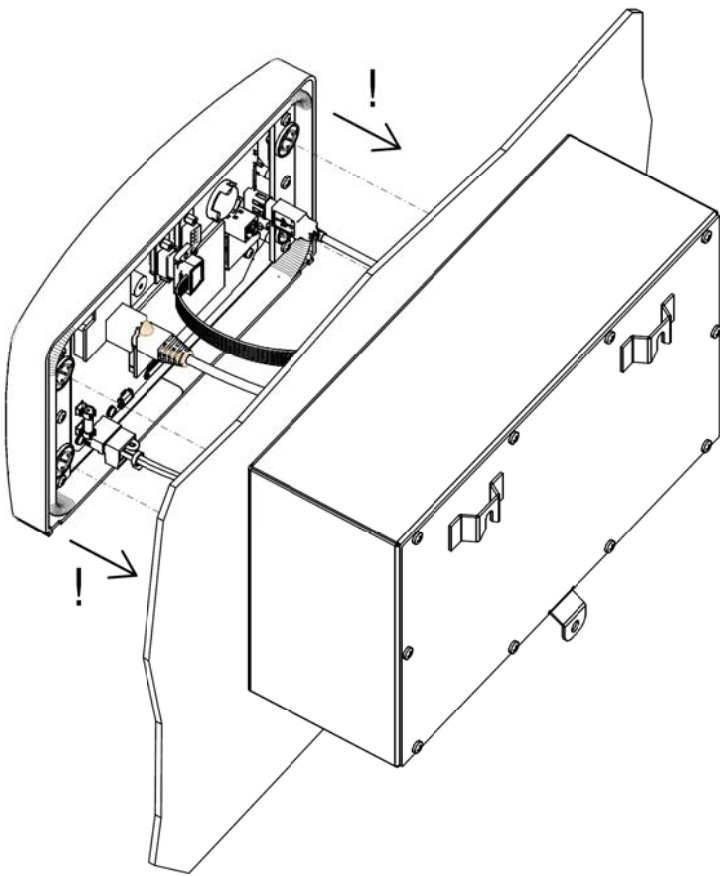

## 6 Commissioning and operation

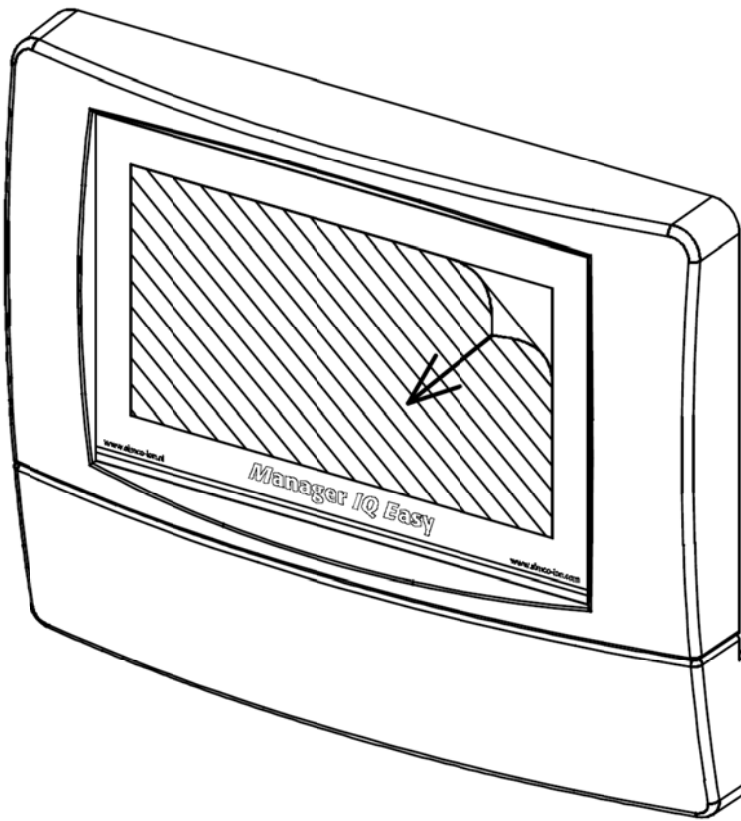

Figure 10, removing the protection film from the display

- First, carefully remove the protection film from the touch screen.

### Switching on

- Make sure that supply voltage is available in the power cable.
- Switch the manager on using the power switch.





### Note:

- **The manager is suitable for continuous operation.**
- **Switching off the manager means that all connected devices no longer receive the supply voltage and hence no longer operational.**

## 6.1 Main screen

After starting, the manager will display the main screen  with

- 6 “not connected” device icons ,
  - An  icon (System Information)
  - An  icon (System settings)
  - Figure 5, 1-5 tabs, depending on the number of Managers IQ Easy and Extensions IQ Easy,
  - a Favorites tab, (not active with 6 or less connected devices)
- Now connect the equipment to the Device ports on the manager. The manager automatically recognizes the devices and the corresponding device icon will appear on the main screen.
- By clicking on a device icon, the Information screen of the device becomes active.

In the *Information (Settings)* Tab and on the various sub pages, parameters and settings can be read out and adjusted.

Tab *Graphics* shows a graphical representation of the operation.

Tab *Action Log* shows logging information regarding the status of the device.



Tab *Datalog* shows important measurement data of the device.

In Tab *Maintenance*, maintenance instructions can be given.



## 6.2 Device Standby & Active

Once a device is connected, recognized, and all information has been gathered by the manager, most devices become will active or inactive, depending on the startup parameter *Autorun*. By default, neutralising equipment will be activated automatically, charging equipment will go into standby mode. See the manual of the device whether this Autorun parameter is present.

On each tab, you can set the device to standby  or active  mode.

The status is indicated in the left upper corner by means of a colour behind the device icon: Green = standby, blue = running, orange = warning, red = alarm.

If a device does not respond to this command, check the Remote on/off source of the device; it should be set to continuous (not Remote input).

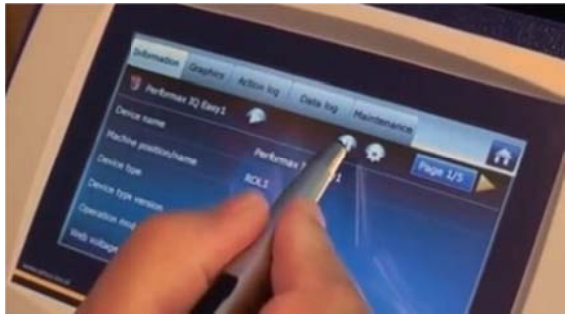

**6.2.1 Global Device Standby & Active**

From the Information (/settings) screen all devices can be set on standby at the same time.





From the Information (/settings) screen all devices with autorun parameter is yes, can be set active at the same time.



**6.3 Device screen tabs**

If a device icon is selected from the main screen, information/settings of the device concerned is displayed on the different types.

**6.3.1 Device Information tab**

From the main screen , select a device icon . Now the Information/settings screen of the selected device is displayed.

In this screen various parameters are displayed, including current measurement values of the device on the various sub screens.

With the   buttons you can scroll through the various pages.

In these screens, various parameters such as name and machine position can be displayed or assigned, but also warning levels, alarm levels and connections between devices can be allocated.

For specific information, see the corresponding manuals of the devices. To adjust parameters, the user must be logged in on a higher user level.

For this, see section 6.4

Depending on the user level the user is logged in on, certain parameters are not displayed.

**6.3.2 Device Graphics tab**

The Graphics tab graphically shows the operation of the device. Important measuring values are shown here as a function of time.

For specific information, see the corresponding manuals of the devices.

If the screen is selected somewhere, the screen will “freeze”, and display *On hold*. Selecting the screen again will display the current value.

### 6.3.3 Device *Action log* tab

In the *Action log* tab, the changing status of the device is logged step-by-step. This is indicated by date and time at which the status change has occurred. For specific information, see the corresponding manuals of the devices.

### 6.3.4 Device *Data log* tab

In the *Data log* tab, available measurement data is logged per device at fixed times. If the parameter *Datalogging* is activated in the device, these values will also be saved in the log file of the manager.

The interval between logging is determined by the setting in the Manager IQ Easy.

See par 6.6.3

For specific information, see the corresponding manuals of the devices.

### 6.3.5 Device *Maintenance Tab*

In the *Maintenance* tab, maintenance instructions can be given.

If the correct user level is selected, in general, the following maintenance instructions can be given:

- *Clear action log*: the action log of the device will be erased.
- *Clear data log*: the data log of the device will be erased.
- *Restore factory settings*: the device parameters will be reset to factory settings.

For specific information, see the corresponding manuals of the devices.

## 6.4 Selecting user levels (access protection)

For selectively displaying and setting information, the manager has 4 defined user levels. For 2 levels a password can be set.

- Basic, the user can only see the parameters but not adjust them.
- Advanced, the user can adjust a limited number of basic parameters.
- Expert, the user can adjust all parameters during commissioning and maintenance of the system (intended for technical service).
- Service, Simco-Ion service staff only.



Select the main screen of the Manager 

Select the settings  icon: now the user level choice is activated. This choice is later used in various devices as well.



Select the desired user level. If set, enter the password and confirm with . This level is now adjusted.

The selected level can be checked in the System setting pages, after parameter *Userlevel*.

Depending on the selected level, no, some or several  icons will appear behind the parameters that can be adjusted for both the manager and the various connected devices.

By clicking the  icon, the input screen of the parameter appears. The change is saved automatically after activation of the selected parameter or by selecting the  button.







If another user level is desired, go to the main screen  and click on .



 **Note:**

- As long as no password is set for the Advanced and Expert mode, these modes are freely accessible. See section 6.9.
- The Manager IQ Easy remains in the selected user level until it is modified. After maintenance in a higher level restore the desired level.

### 6.4.1 Setting the Password for advanced mode and expert mode

On the main screen , click on the  icon and select Expert (or optionally *advanced*) (*System Settings*).

Use   to browse through the parameters to parameter *Advanced password*, select  and enter the desired password and confirm this with .

Select  behind *Expert password*, enter the desired password and confirm with .

### 6.4.2 Reset Password

To reset forgotten passwords, follow the procedure below:

Advanced: Log on at expert level and reset password for advanced.

Expert mode: contact Simco-Ion.





### 6.5 Setting device parameters on the Information screen

-  If an "Undefined param" appears on the info screen of a device at the Manager, the manager must be updated with the latest software.  
Download the latest software version on [www.simco-ion.co.uk/software](http://www.simco-ion.co.uk/software) and follow the "Upgrade" instructions as described in the Manager manual.

Specific parameters can be set for each device. A number of the usual parameters will be displayed. Depending on the level you have logged in at, parameters will be visible and possibly also adjustable.

For specific information, see the corresponding manuals of the devices.

To adjust all parameters select , the device icon,  and "expert".

Once logged on you can directly scroll to the parameters   and adjust them without selecting   again.





#### 6.5.1 Setting the Device name, Device Machine position

To make a device more recognizable, a specific name can be assigned to a device.

If desired, adjust the parameters: Device name, Machine position,

- Select the information page with the parameters to be changed by:



- [, device pictogram, , (n)x  “parameter  ”enter name or value” and confirm with ]

### 6.5.2 Setting the Device Graphic refresh time (expert mode)

For several devices, the speed at which the screen in the *Graphics* tab is refreshed can be set.

- Select the information page with the parameters to be changed by:





- [, Device icon, , (n)x  “parameter  ” and select time]

### 6.5.3 Switching Device Remote on/off through the remote on/off input on the Machine I/O connector or via fieldbus (expert mode)





If desired the device can be switched on and off using the remote on/off input of the Manager (Machine I/O connector for machine control or PLC) or by means of an instruction of the optional Fieldbus.

With this, machine control can switch several selected devices on/off at the same time, without having the operator performing any actions.

To select this the parameter *Remote on/off source* parameter of the device has to be changed from *Continuous* to *Remote* or *Fieldbus* (not available for every device).

- [, device icon, , (n)x  “*Remote on/off source*”  select *Remote* or *Fieldbus* ]

To undo this and have the device react on commands of the previous source again:

- [, device icon, , (n)x  “*Remote on/off source*”  select “*Continuous*”]

### 6.5.4 (De)activating Device Data logging (expert mode)

If desired, the manager can log data in a file regarding the operation of a device.

The data logging on the screen on tab *Data log* is present at all times.

To (de)activate data logging, the parameter *Data logging* has to be changed.

- [, device icon, , (n)x  “*Data logging*”  select *On* or *Off* ]

See section 7.3 for detailed information on exporting data log data.

### 6.5.5 Adjusting the Device Autorun parameter (expert mode)





Most devices will have an *Autorun* parameter that determines whether the device will be automatically activated after a power interruption or after connecting the device. Select whether this is desired:

- [, device icon, , (n)x  “*Autorun*”  , No / Yes ]

### 6.5.6 Setting the Device pictogram Favorites screen position (expert mode)

If more than 6 devices can be connected to a system (via Extension IQ Easy), the *FAVORITES* tab on the main screen will become active.



On this *FAVORITES* screen the status of the most important devices can be viewed at once. To assign a place for the device on the screen, the position can be defined (numbering 1, 2, 3 from left on the upper row to 4, 5, and 6 on the lower row:

- [, device icon, , (n)x  “Favorites screen position” , select number or none]

### 6.6 Setting Manager parameters in Global Settings screen (expert mode)

Various settings of the manager itself are displayed by selecting the information ,  icon.

To adjust the parameters select , , and then “expert”.





Once logged in you can directly scroll to the parameters and adjust them without selecting ,  again.

If the user is logged in at a lower user level, not all parameters will be displayed.

#### 6.6.1 Setting Manager name, Manager Machine position

To make the manager more recognisable on the screen and in the data log file, a specific name can be assigned to the manager.

If desired, adjust the parameters: Device name, Machine position:





- Select the information page with the parameters to be changed by:
- [, , (n)x  parameter , enter name or value, confirm with  ]

#### 6.6.2 (De)activating Manager Data logging (expert mode)

If desired, the manager can log data in a file regarding the operation.

The data logging on the tab data logging is present at all times.



To (de)activate data logging, the parameter *Data logging* has to be changed.

- [, , (n)x  “Data logging” , select *On* or *Off* ]

See section 7.3 for detailed information on exporting data log data.





#### 6.6.3 Setting the Datalog refresh time (expert mode)

The time between each log interval (for both manager and devices) can be adjusted.

- [, , (n)x  “Logfile refresh time” , select interval]

#### 6.6.4 Changing date and time format (expert mode)

The way date and time are noted can be adjusted.

- [, , (n)x  “Date format” , select DD-MM-YYYY or YYYY/MM/DD or DD.MM.YYYY ]

## 6.6.5 Switching buzzer on/off or adjusting it (expert mode)

During every button selection, a tone will sound by default. Changes are effective if the main screen is selected after making a choice.

To activate or deactivate:

- [  , (n)x  "Buzzer"  select on or off ]

To adjust the pitch level:

- [  , (n)x  "Buzzer frequency"  slide slider or set  to the desired value and confirm with  ]

To adjust the tone length:

- [  , (n)x  "Buzzer beep length"  slide slider or set  to the desired value and confirm with  ]



## 6.6.6 Retrieving Ethernet IP address (expert mode)



The DHCP Ethernet IP address assigned by the router can be retrieved.



- [   or , (n)x  "Ethernet IP address" ]

## 6.7 Setting Manager Backplane parameters in Global Settings screen (expert mode)

All device ports and other I/O ports are controlled through the IQ Easy Backplane interface. This interface has its own settings and software.

Various settings of the manager Backplane are displayed, when  first the 1 tab and then the information  icon is selected on the main screen.

To adjust the parameters, make sure you are logged in at the expert user level, then select  "1",  and then .

Once logged in you can directly scroll to the parameters and adjust them without selecting ,  again.

If the user is logged in at a lower user level, not all parameters will be displayed. A particular name can be assigned to the Backplane as well.

### 6.7.1 Manager Backplane Device time-out (expert mode)

Should the communication between the Backplane and a device be interrupted, an attempt will be made to reestablish communication. If this isn't accomplished within the device time out, the device will be signed out of the system (grey screen).

These can be set by

- [  "1", , , (n)x  "Device time-out" , enter time and confirm with  ]

## 6.7.2 Manager Backplane RS485 A & B line switch (expert mode)

The Backplane can switch the RS485 lines in order to establish communication with a device. This parameter is activated by default. With this parameter certain wiring errors can also be corrected automatically.

This automatic switching can be deactivated:

- [  "1", , , (n)x  "Toggle RS485 AB"  , select off or on ]



## 6.7.3 Manager Backplane Autorun parameter

The Backplane *Autorun* parameter is always on by default. This way the Backplane is activated automatically after a power interruption.

## 6.7.4 Making Device Port 5 & 6 suitable for non IQ Devices or IQ devices (expert mode)

If you need to connect 24 V DC Simco-Ion devices, which have no IQ interface, but an analog interface with remote on/off and HV-OK, these devices can be connected to the IQ platform with limited options. Device port 5 and 6 have been prepared for this. The analog device can be set to standby or active mode with the manager and the HV-OK signal will be displayed by the manager.

(OK= blue, Not OK= yellow= warning)

- [  "1", , , (n)x  "Port5 mode"  , select Analog I/O (non IQ) or Serial (IQ)]
- [  "1", , , (n)x  "Port6 mode"  , select Analog I/O (non IQ) or Serial (IQ)]

## 6.7.5 Switching Machine I/O digital output between Open Emitter and Open Collector (expert mode)

Depending on the input of the machine control, the digital output can be switched from Open Emitter OE to Open Collector OC. See section 5.4.4.1.

- [  "1", , , (n)x  "OE/OC Mode"  , select OC or OE]

## 7 Functional check

The manager is operating properly if the (device) icons are visible and the status of the connected devices is displayed on the home screen .

### 7.1 Warnings

The manager generates a warning when a device or the manager detects a situation requiring the user's attention. The particular device will keep functioning and, if necessary, be switched into a safe mode. A warning will be displayed with an orange/yellow indication in the device icons.

### 7.2 Alarms

The manager generates an alarm if a device or the manager detects a situation in which the values set by the user or Simco-Ion are exceeded, which may lead to a dangerous situation. To

prevent damage, the relevant device will be switched off in most cases. An alarm with a red indication will be displayed.

### 7.3 Data logging (as of **Software version V1.1.0** of the manager)

An Action log and data log is kept on all devices in an IQ platform.

The last logging data can be displayed on the screen.

For devices whose *Datalog* parameter have been set to “on”, these will be written into a file as well. The data is saved in CSV files (Excel format).





A separate action log and data log file is generated every day for each device.

14 days are saved in the manager in total; after that, the oldest file will be overwritten.

#### 7.3.1 Copy data from internal memory to PC

To copy the data log data of the manager to your PC, the manager must be connected to a network in which the router has assigned an IP address to the manager via DHCP.

Make sure that the Manager IQ Easy is connected to a working router during startup of the manager. Otherwise restart (power down/up) the manager before carrying out the steps below.

- Log in as expert ,  “expert”.
- Retrieve the IP address via [, , (n)x  “Ethernet IP address” ].
- Open an (internet) browser on a PC within the same network.
- Enter: ftp://”IPAddress”/storagecard into the address bar and refresh the page. For example ftp://192.168.1.3/storagecard
- The browser will now display a pop up asking for a password.
- In Username enter: Simco
- Password: 1234
- Select sign up/log in

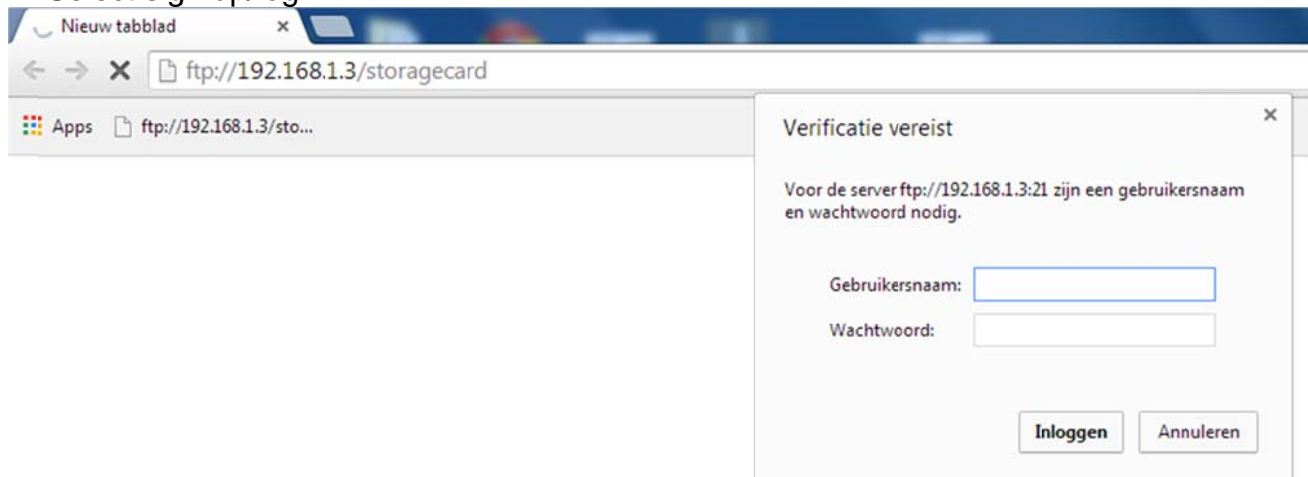

- The storagecard folder of the manager will be opened.



- Select the folder log files how you normally do, possibly with the explorer.
- Copy the files to your PC after which they can be opened in Excel or a different program.



### 7.3.2 Data logging to USB

If a USB storage device is plugged into a USB port of the manager during startup, the log file will automatically be written onto the USB storage device. If the USB storage device is removed or not present, the data will be written onto the internal storagecard.

- Create a map “logfiles” in the root path of the USB storage device, using a PC.
- Switch off manager
- Insert the USB stick into a USB port of the manager
- Switch the manager on

CSV files of datalogging are now written to the USB stick.

## 8 Maintenance

The Manager IQ Easy does not require regular maintenance. Keep it clean by not working with dirty fingers. If the display needs to be cleaned, use a commercially available PC screen cleaning cloth.

Check the connection cables regularly for damage. Replace damaged connection cables immediately.



## 9 Faults



### Warning:

- The electrical installation must be carried out by an electrical engineer with the relevant training and qualifications.

Table 1, faults

Problem	Cause	Solution
No screen is displayed on the display and the device LED's do not light up	No supply voltage	Turn the power switch to <i>on</i>
		Supply 24 V DC or 100-230 V AC
		check the wiring.
No screen is displayed, but the device LEDs do light up	The Backplane works, but the touch screen doesn't	Check the internal wiring from the Backplane to the touch screen (5.5)
	Touch screen is frozen	Power down/power up
IQ device connected to port 5 or 6 doesn't work	Port is configured for Non IQ (analog) device	Change Backplane setting for port 5 or 6 to IQ
Device is not recognised by Manager	Communication is not established	Check the wiring
		Detach the device and reconnect (same or other port)
		Change the RS485 A&B switch parameter and retry
		Check if a Simco-Ion IQ suitable device is connected (rating plate)
Device cannot be switched on or off using the screen (icons change, but the device remains in the same status)	Device is configured to react to the remote on/off input of the machine control/PLC	Change remote on/off source parameter to Continuous
Data is not saved onto the USB flash drive.	USB flash drive is not recognised.	Power down and then power up with USB flash drive plugged into the manager
	Folder "log files" is not present in the root path of the USB stick	Create a map "log files" directly in the root path
FTP address is not opened in the browser	Address displayed in settings is an outdated address.	Make sure that the manager is connected to the network, then power down and up, retrieve the new address and enter this address in the browser.

## 10 Repairs



### Warning:

- Repairs must be carried out by an electrical engineer with the relevant training and qualifications.
- The electrical installation and repair must be carried out by an electrical engineer with the relevant training and qualifications and in accordance with the applicable national and local regulations.

Parts of the manager cannot be repaired. To order parts, see the spare parts list.

Simco-Ion advises you to send the manager to Simco-Ion for repairs.

Request an RMA form by sending an e-mail to [service@simco-ion.nl](mailto:service@simco-ion.nl).

Pack the manager properly and clearly state the reason for return.

## 11 Disposal

Observe the applicable local environmental regulations when disposing of the equipment.

OR



At the end of its service life, do not throw the device away with the normal waste but hand it in at an official collection point.

By doing so, you will help to protect the environment.



## Spare parts

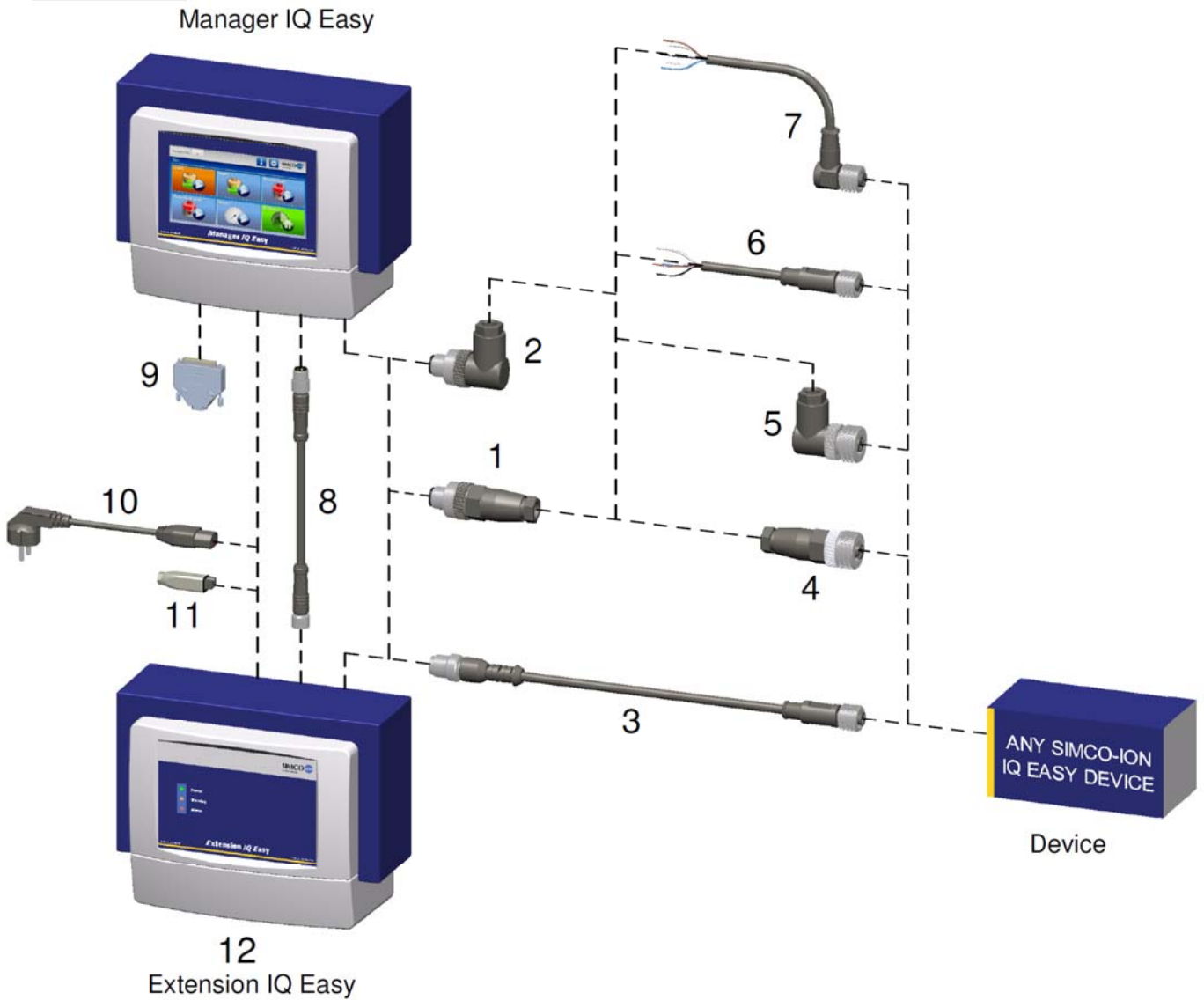

### Connectors and connecting cables DEVICES

3	7519020390	Cable device M12 female-male straight 2 m
	7519020391	Cable device M12 female-male straight 5 m
	7519020392	Cable device M12 female-male straight 10 m
	7519020386	Cable device M12 female-male straight 5 m for cable chain
	7519020387	Cable device M12 female-male straight 10 m for cable chain
	7519020383	Cable device M12 female-male straight 5 m shielded for cable chain
	7519020384	Cable device M12 female-male straight 10 m shielded for cable chain
1	7519020352	Connector IQ M12 male straight $\varnothing$ 4-6 mm cables
	7519020353	Connector IQ M12 male straight $\varnothing$ 6-8 mm cables
2	7519020357	Connector IQ M12 male right-angled $\varnothing$ 4-6 mm cables
	7519020358	Connector IQ M12 male right-angled $\varnothing$ 6-8 mm cables
4	7519020350	Connector device M12 female straight $\varnothing$ 4-6 mm cables
	7519020351	Connector device M12 female straight $\varnothing$ 6-8 mm cables
5	7519020355	Connector device M12 male right-angled $\varnothing$ 4-6 mm cables
	7519020356	Connector device M12 male right-angled $\varnothing$ 6-8 mm cables

- |   |            |  |
|---|------------|--|
| 6 | 7519020365 | Cable device M12 female straight 5 m                           |
|   | 7519020366 | Cable device M12 female straight 10 m                          |
|   | 7519020380 | Cable device M12 female straight 10 m shielded for cable chain |
| 7 | 7519020375 | Cable device M12 female right-angled 5 m                       |
|   | 7519020376 | Cable device M12 female right-angled 10 m                      |

#### Connecting cables COMM

- |   |            |                                       |
|---|------------|---------------------------------------|
| 8 | 7519020291 | Cable IQ M8 female-male straight 5 m  |
|   | 7519020292 | Cable IQ M8 female-male straight 10 m |
|   | 7519020294 | Cable IQ M8 female-male straight 25 m |

#### Other parts

- |    |            |   |
|----|------------|---|
| 9  | 3900236025 | Connector Sub-D 25p male                            |
| 10 | 9146340700 | Power cord 230 V IEC-C13, 2m                        |
| 11 | 9370000205 | Power connector 24 V, ø4 - 6,5 mm cables            |
| 12 | 1030000100 | Extension IQ Easy DC 24V                            |
|    | 1030000110 | Extension IQ Easy AC 100-240V                       |
| -  | 9102502032 | Internal Battery Manager IQ Easy 3V (CR2032)        |
| -  | 4030000000 | Front Panel Manager IQ Easy complete, including HMI |

Spare parts can be obtained from the agent in your region or from SIMCO (Nederland) B.V.

SIMCO (Nederland) B.V.  
 Postbus 71  
 7240 AB Lochem - The Netherlands  
 Telephone +31-(0)573-288333  
 Fax +31-(0)573-257319  
 E-mail [general@simco-ion.nl](mailto:general@simco-ion.nl)  
 Internet <http://www.simco-ion.nl>